



EDGE



EDGE

ALL SPACES

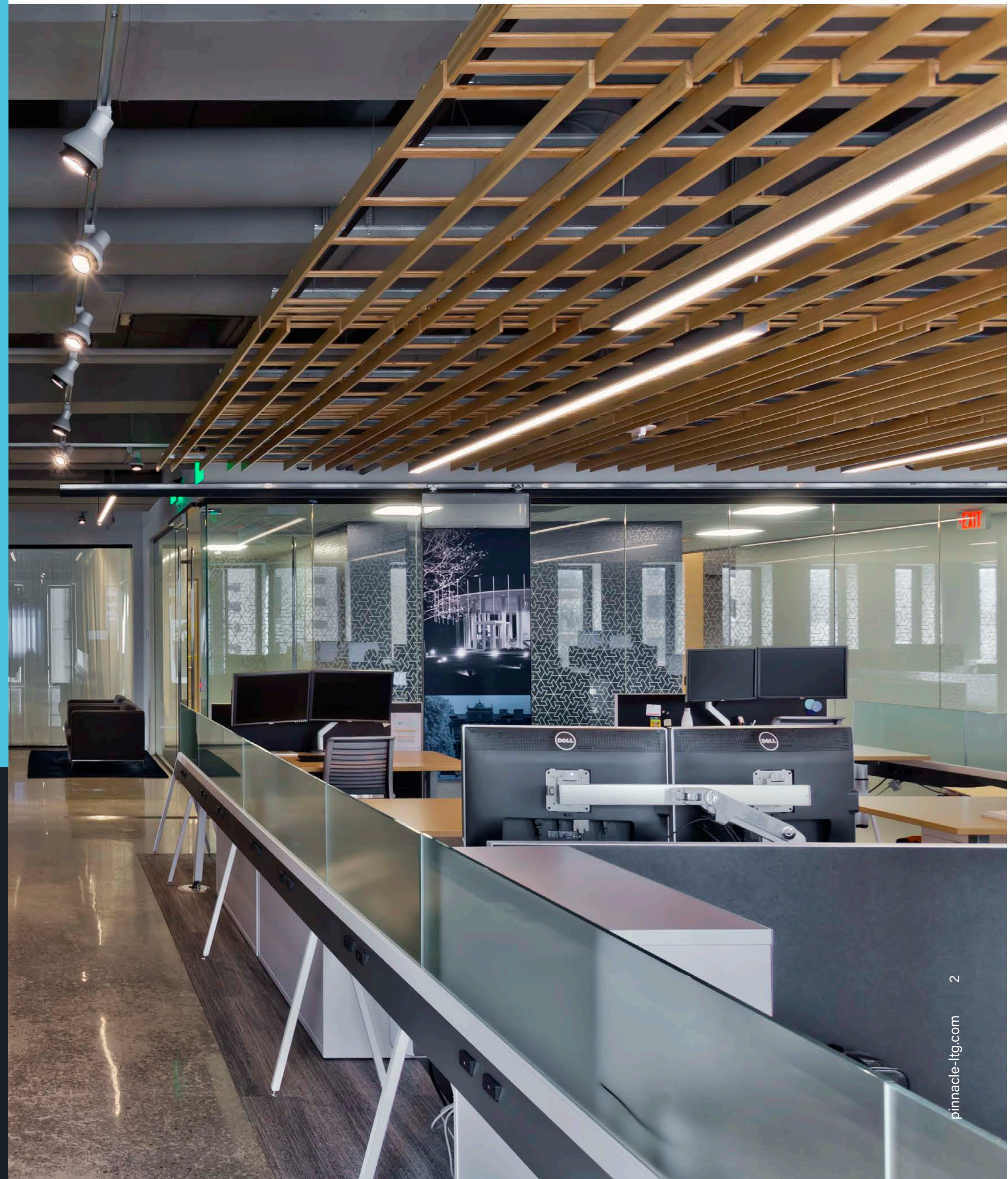

ALL SIZES

Pinnacle Architectural Lighting's EDGE Family has it all – the sizes, configurations, distributions, and custom capabilities to illuminate each space in a design. Every available aperture width allows for perfect lines of light in individual fixtures and continuous rows. Specify every detail of each fixture to make it blend in to the space or stand out as a statement.

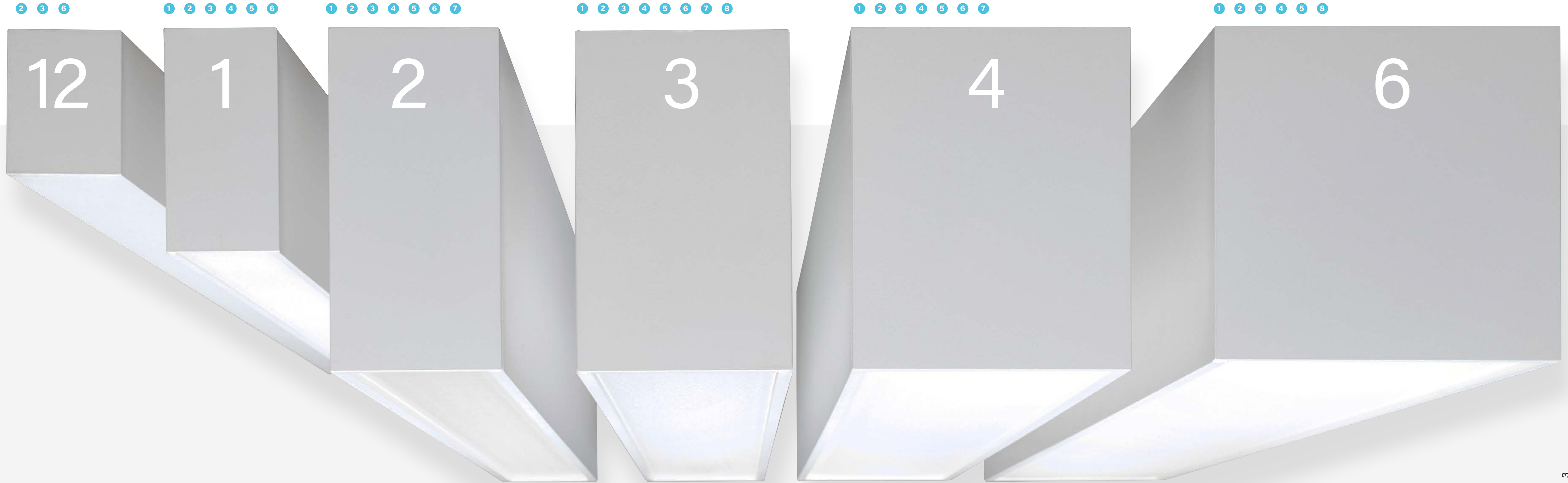
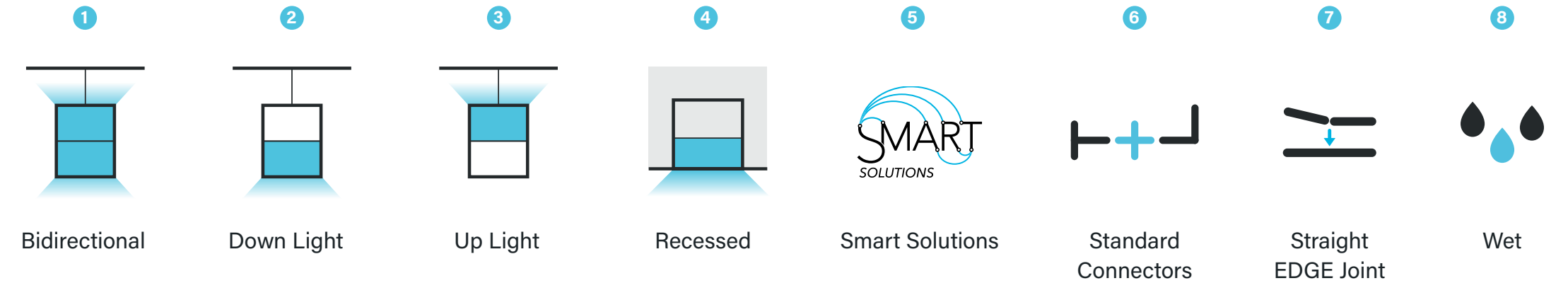

ALL DISTRIBUTIONS

1 Co-Extrusion
The combination of diffuse and reflective material provides optimal lens illumination, efficacy, and control of the beam shape.

2 Reflector
Designed with both an idealized parabolic shape and near absolute reflective material.

3 Lensing
Engineered acrylic provides just the right amount of diffusion with minimal light loss.

A fully luminous lens for both asymmetric and batwing distributions.



Highlight the architectural details in your design by specifying one of the multiple shielding options available.

Direct shielding



Indirect shielding

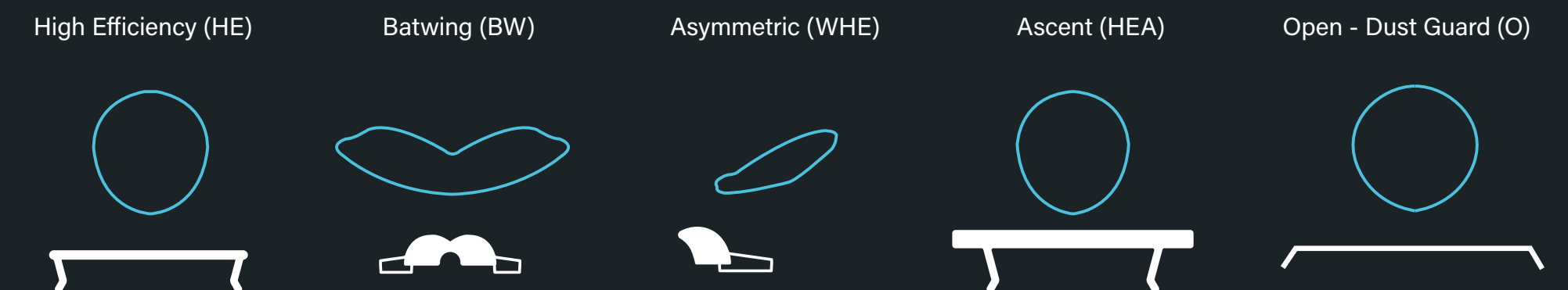



ALL CONNECTED

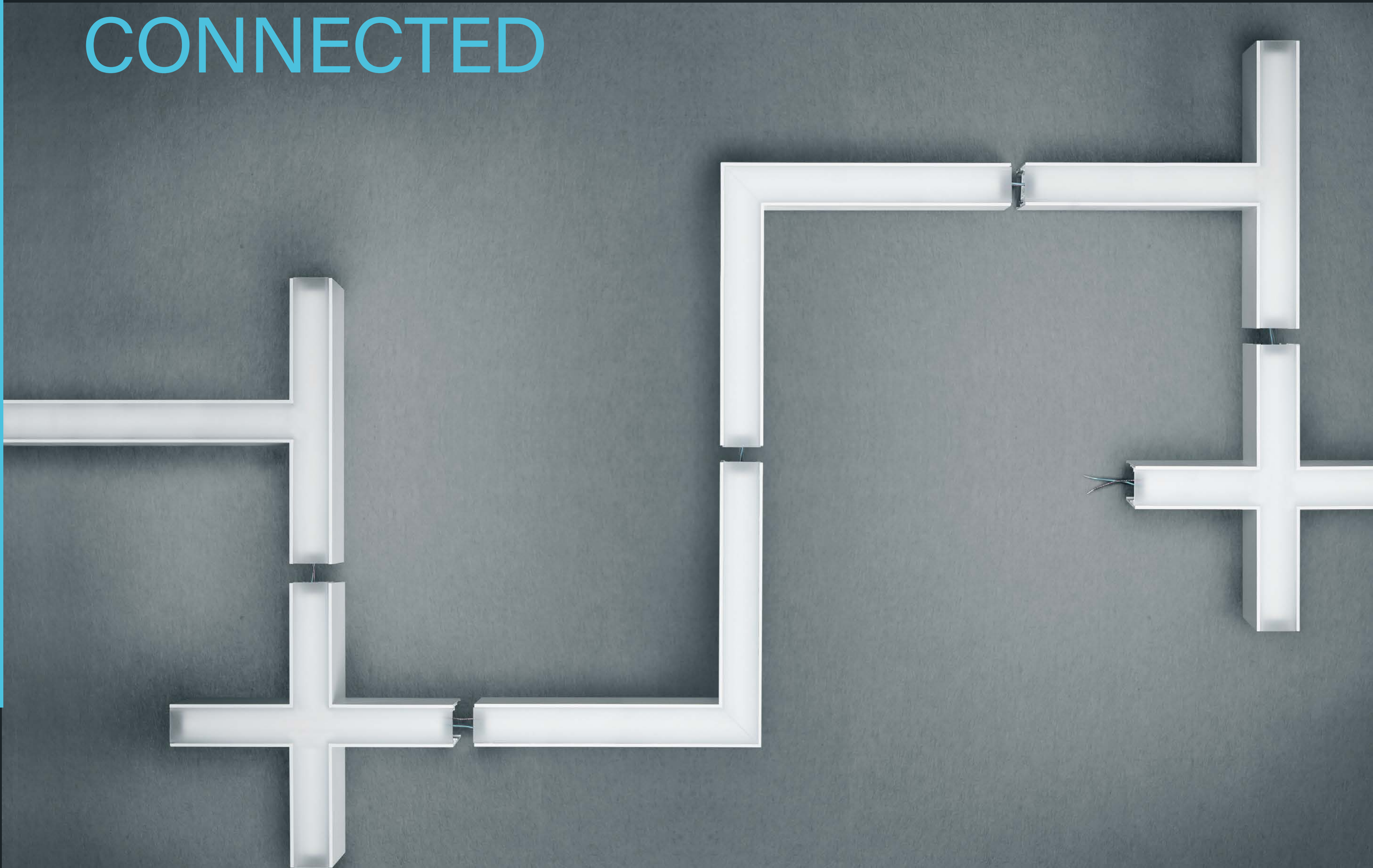

EDGE offers various corners and connectors to transform simple lines of light into complex illuminated patterns.

Choose from inside, outside and horizontal corners. Embellish runs with T and X-connectors.

ALL CUSTOM



We understand that our standard product may not fit in to every lighting design.

Our dedicated Sales Engineering Team will work with you on every detail from concept through installation to ensure perfect lines of light for every architectural space.

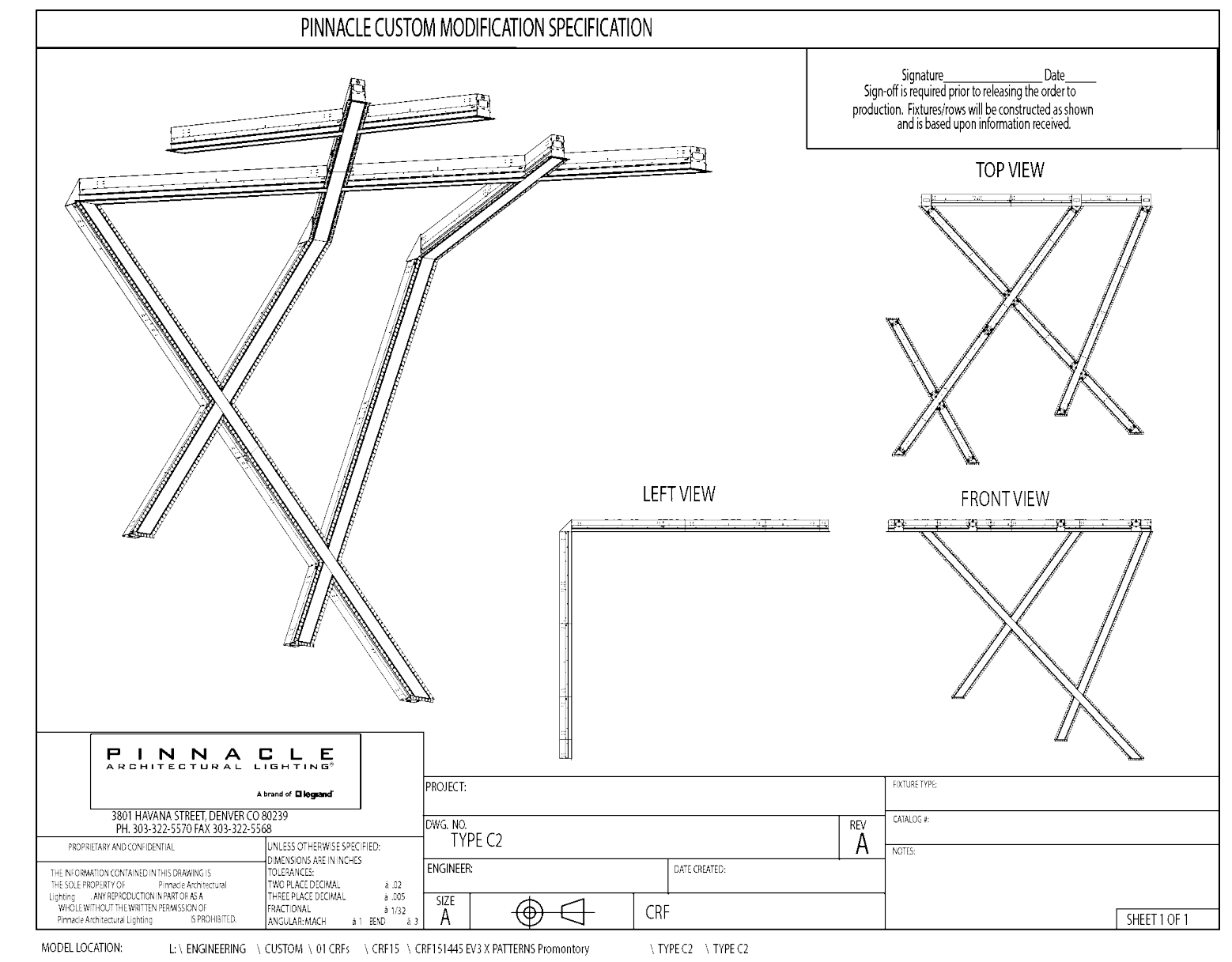

ALL STRAIGHT ROWS

A revolutionary design like nothing else in the industry. The patented Straight Edge Joint cinches fixtures together, leaving no space for light leaks and forming straight lines in the process.

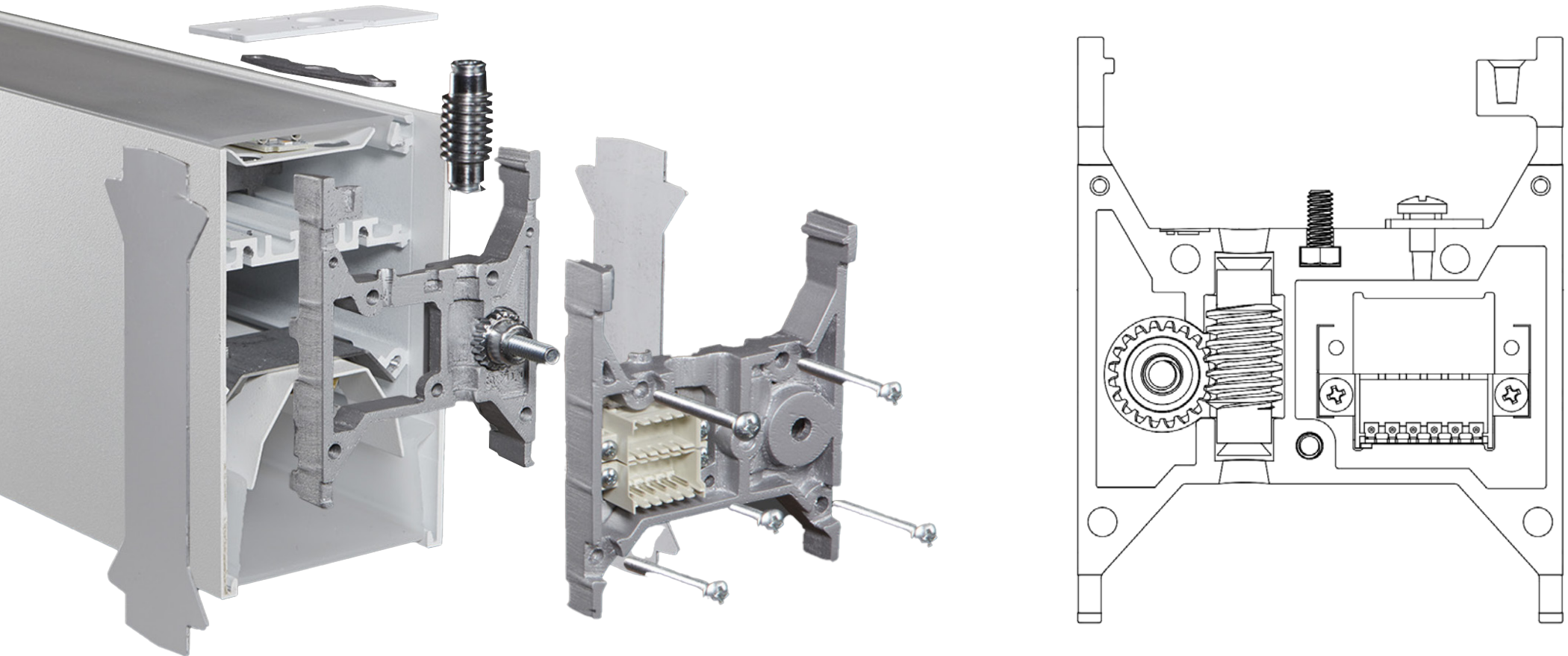

Before

Multiple fixtures in a run have a tendency to “snake” once they are joined together.



After

The Straight Edge Joint has a pivot point at each connection that allows the individual fixtures to align perfectly for a straight run.



ALL
DONE





P I N N A C L E
ARCHITECTURAL LIGHTING®

3801 Havana St. Denver CO, 80239

Phone: 303.322.5570

www.pinnacle-ltg.com

December 2020

© 2020 Pinnacle Architectural
Lighting®

Specifications and dimensions subject to change without notice. Specification sheets and brochures that appear on pinnacle-ltg.com are the most recent version and supersede all other previously printed or electronic versions.