

CONSTRUCTION Extruded aluminum housing, die-cast gasketed end caps. Outdoor rated luminaires include mechanically attached and gasketed aluminum door frame.

REFLECTOR Highly reflective specular anodized aluminum.

LENS Micro-prismatic tempered glass and die-formed aluminum trim (spring secured) for tool-less lamp access. For outdoor luminaires, glass is secured to aluminum door frame and mechanically attaches to housing.

ELECTRICAL Standard 120/277 volt integral electronic ballast with a power factor greater than 90% and less than 15% THD. Consult factory for battery packs and dimming. Each ballast provided with disconnects to meet luminaire disconnect code requirement.

MOUNTING Fully rotatable head mounts to structure either at ceiling or wall.

FINISH Standard powder-coat white textured painted finish. Consult factory for custom color and finishes.

LABELS UL and cUL Listed and approved for dry/damp location or wet location. Specify label required under "Product" section of catalog number.

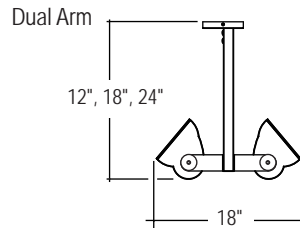
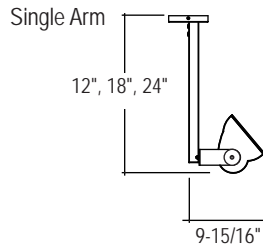

For Indoor and Outdoor Lighting Applications

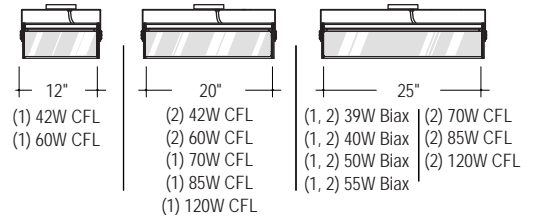

LUMINAIRE SPECIFICATION

Sample Catalog #: PLS-CF60-A112-120-1C-W-V

PRODUCT	LAMPS / LENGTH	MOUNTING	VOLTAGE	CIRCUITING	FINISH	OPTIONS
PLS- Peak Large indoor luminaire, Smooth Housing, dry/damp label	LAMP LENGTH CF42- (1) 42W CFL 12" CF60- (1) 60W CFL 12"	REMOTE BALLAST ^{1,2,3} A1_ Arm Mount/Single Head (specify O.A.L., 12", 18" or 24") A2_ Arm Mount/Dual Head (specify O.A.L., 12", 18" or 24")	120- 120 V 277- 277 V 347- 347 V ⁴ UNV- UNV (120/277)	1C- Single Circuit 2C- Dual Circuit ⁵ 1D- Single Circuit with Dimming ⁵ 2D- Dual Circuit with Dimming ⁵ 1B- Single Circuit with Battery Pack ⁵ 2B- Dual Circuit with Battery Pack ⁵	W- Matte White S- Metallic Silver BR- Bronze CC- Custom Color	B- Baffle ⁶ V- Visor ⁶
PLR- Peak Large indoor luminaire, Ribbed Housing, dry/damp label	2CF42- (2) 42W CFL 20" 2CF60- (2) 60W CFL 20" CF70- (1) 70W CFL 20" CF85- (1) 85W CFL 20" CF120- (1) 120 W CFL 20"					
PLSW- Peak Large outdoor luminaire, Smooth Housing, wet label	2CF70- (2) 70W CFL 25" 2CF85- (2) 85W CFL 25" 2CF120- (2) 120W CFL 25"					
PLRW- Peak Large outdoor luminaire, Ribbed Housing, wet label	BX39- (1) 39W Biax 25" 2BX39- (2) 39W Biax 25" BX40- (1) 40W Biax 25" 2BX40- (2) 40W Biax 25" BX50- (1) 50W Biax 25" 2BX50- (2) 50W Biax 25" BX55- (1) 55W Biax 25" 2BX55- (2) 55W Biax 25"					
PLSN- Peak Large natatorium luminaire, Smooth Housing, wet label						
PLRN- Peak Large natatorium luminaire, Ribbed Housing, wet label						

¹ Remote wiring for CFL allowed to a maximum of 6' for 2-lamp or 15' for 1-lamp between ballast and lamp holder.
² Biax ballast installed into fixture head.
³ Arm lengths 24" or longer require aircraft cable support when mounted to the wall. Consult factory.
⁴ Not available with compact fluorescent. Consult factory for biax lamp. Not all lamping options are available.
⁵ Some Peak Large configurations will not accommodate all electrical options. Consult factory.
⁶ Color will match housing unless otherwise specified.

AIMING

Fixture achieves optimal beam angle (a) when "aiming notch" (b) aligns with horizontal or vertical axis. Luminaire head rotates and locks for easy field adjustability.

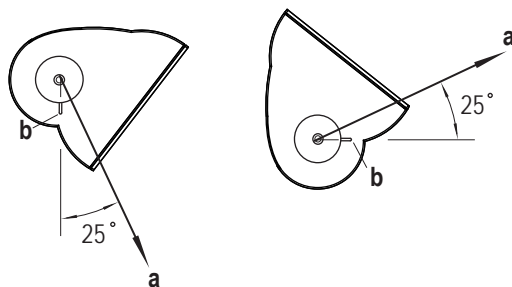

MOUNTING DIMENSION

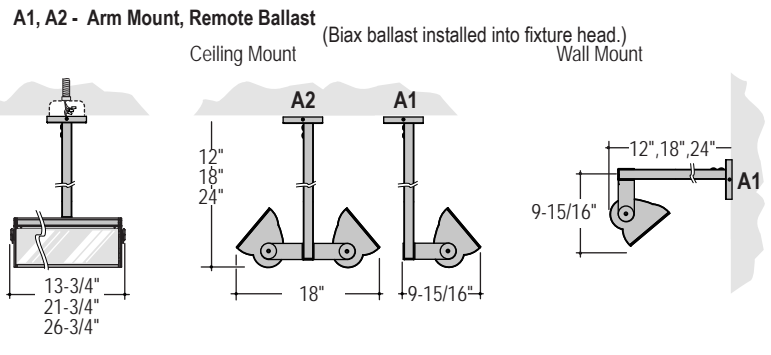

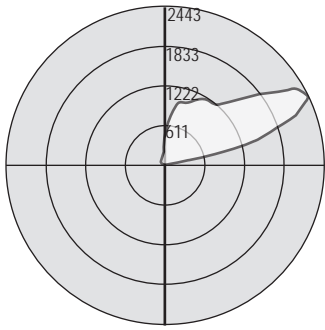

Test # JTL-200046
 Catalog # PL-BX55
 Total Luminaire Efficiency = 66.20%

Zone	Lumens	%Lamp	%Fixt
0-30	0	0	0
0-40	0	0	0
0-60	0	0	0
0-90	34.0	.7	1.1
90-120	1390.9	29	43.8
90-130	1953.5	40.7	61.5
90-150	2719.7	56.7	85.6
90-180	3141.6	65.5	98.9
0-180	3175.6	66.2	100

0	0	45	90	135	180
0	0	0	0	0	0
5	0	0	0	0	0
15	0	0	0	0	0
25	0	0	0	0	0
35	0	0	0	0	0
45	0	0	0	0	0
55	0	0	0	0	0
65	0	0	0	0	0
75	0	.35	0	0	0
85	126	84	.17	0	0
95	105	180	36	.07	.04
105	1504	1292	131	11	2.5
115	2443	1480	221	37	23
125	1920	1090	270	61	44
135	1307	1070	359	76	67
145	1211	1068	364	94	77
155	1084	985	410	98	89
165	1007	896	424	108	93
170	886	762	397	108	96

FEATURES AND OPTIONS

• EXTERNAL BAFFLE

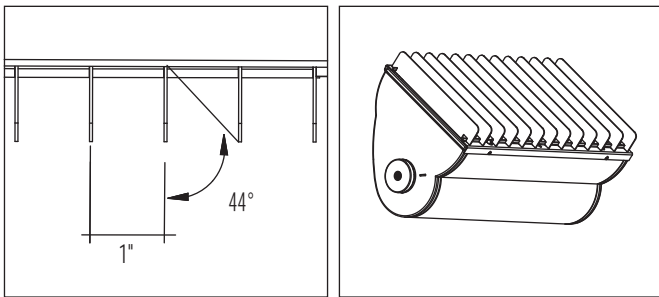

Application: External Baffle controls glare and reduces light output by 15%. Recommended when lengthwise shielding of lamp is required.

Construction: Straight baffles are high reflective white painted aluminum blades. Blade height is 1-1/8" and spaced 1" on center. Baffles are factory installed and can be easily removed for lamp replacement.

Ordering Information: Indicate "B" in the Options section of the part number. (Sample Catalog #: PLS-BX55-A112-120-1C-W-B).

• VISOR

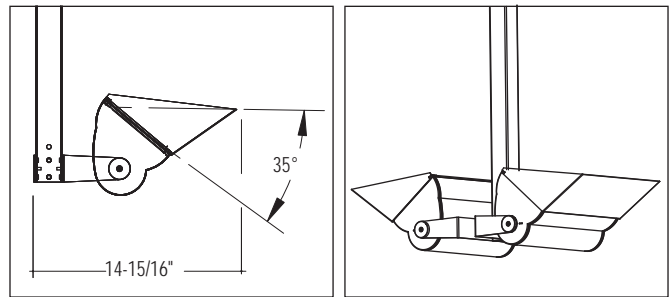

Application: Provides 35 degrees of shielding with no interference to peak beam angle. Recommended when glare from the lens or reflector must be shielded.

Construction: Solid formed visor mounts to fixture with 2 screws. Visors are field installed. Visors are painted to match fixture housing unless otherwise specified.

Ordering Information: Indicate a "V" in the Options section of the part number. (Sample Catalog #: PLS-BX55-A112-120-1C-W-V)

• MOUNTING DETAIL

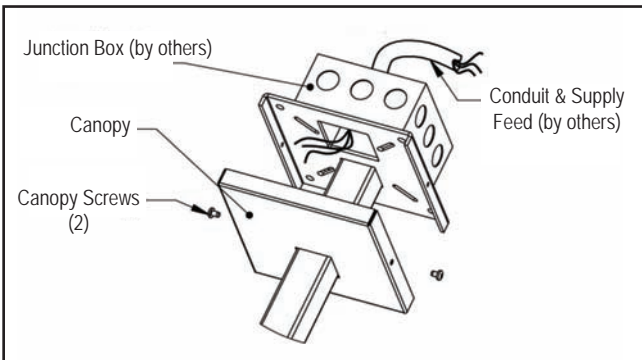

Assembly: Pendant easily installs to junction box and/or structure. Canopy slides down allowing for fixture wires to be fed through arm. Attach to building power, slide canopy back into place and attach using canopy screws. See installation instructions when installing fixtures. Specification sheets are not to be used as installation instructions.