

SORREL S3D

3" Suspended Direct/Indirect Linear

Specification Features

- Open triangular shape creates unique aesthetic while providing functional output.
- Combined suspension and power cable for clean installation.
- Standard connectors allow the fixtures to move effortlessly throughout the space.
- Direct fixtures distribution changes slightly between A lens and D lens. A lens distribution is 80% direct /20% indirect and D lens is 85% direct /15% indirect.



Example Part #: S3D-A-830HO-26'-CAC48JB-U-FSD-1-0-W



SHIELDING	CRI, CCT & OUTPUT ¹	LENGTH OR PATTERN ²	MOUNTING ³
A - Satine Dual Lens D - Diffuse Single Piece Lens <i>Shielding pg. 2</i>	_27_ - 2700K _30_ - 3000K _35_ - 3500K _40_ - 4000K CL - Custom Lumens CW - Custom Watts <i>Lumen Output Options pg. 2</i>	_ - Individual Fixture (2', 3', 4', 5', 6', 7' & 8') _ - Continuous Row S - Square R_x - Rectangle L_x - L-Shape U_x_x - U-Shape Y_x_x - Y-Shape X_x_x_x - X-Shape <i>Length and Pattern pg. 2-3</i>	CAC_g - Conductive AC to Grid CAC_JB - Conductive AC to J Box <i>Mounting pg. 3</i>
VOLTAGE	REMOTE DRIVER	CIRCUITING	BATTERY & EMERGENCY ⁴
U - Universal (120 thru 277V) 1 - 120V 2 - 277V 3 - 347V <i>Voltage pg. 4</i>	FSD - Factory Select Driver (1%, 0-10v) PL2 - Advance Xitanium (1%, 0-10v) PL4 - Advance Xitanium (1%, 0-10v, 347v) OL2 - eldoLED Optotronic (1%, 0-10v) EE1 - eldoLED ECOdrive (1%, 0-10v) ES1 - eldoLED SOLOdrive (0%, 0-10v) LH1 - Lutron Hi-lume (1%, EcoSystem) <i>Driver pg. 4</i>	1 - Single Circuit E - Emergency (entire fixture or row) N - Night Light (entire fixture or row) <i>Circuiting pg. 4</i>	0 - None _FSB - Factory Select Battery _PLL - Bodine 10W Battery _ILL - Iota 10W Battery _FSG - Factory Select ALCR Emergency Control Device _GI - Iota ETS DR, Emergency Control Device _GB - Bodine GTD, Emergency Control Device _E - Emergency Section _N - Night Light Section <i>Battery and Emergency pg. 5</i>
FINISH	CONTROLS		
W - White S - Metallic Silver BL - Textured Black BR - Bronze GR - Graphite CC - Custom Color <i>Finish pg. 5</i>	Pinnacle is able to use solutions from different manufacturers. Consult factory for more information.		

¹When specifying CRI, CCT & OUTPUT the first _ is for specifying either 8 - 80CRI or 9 - 90CRI. The ending __ are for specifying output, example HO - High Output. See output charts for more information. ²Individual fixtures come in 2', 3', 4', 5', 6', 7', & 8' lengths. Continuous row comes in 1' increments. When specifying patterns specified length will be fixture length. Patterns will be longer then specified length. ³Specify CAC length standard CAC is 48" Example: CAC48JB. Specify grid: G1=15/16", G9=9/16", GS=Screw Slot. Example: CAC48G1. ⁴Enter quantity for Battery and Emergency, Example 1PLL. Emergency and Night Light section will be entire fixture within row.

Specifications and dimensions subject to change without notice. Specification sheets that appear on pinnacle-ltg.com are the most recent version and supersede all other previously printed or electronic versions.



Shielding

- A - Satine Lens should be used when fixture will be more than 24" away from the ceiling
- D - Diffuse Single Piece Lens should be used when fixture will be less than 24" of the ceiling or near a wall

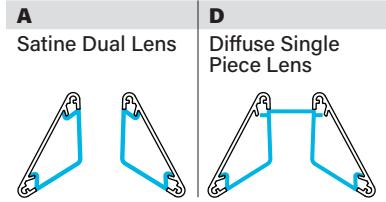

Output

- Specify either 80 or 90 CRI
- Longer lead-time may apply for 90 CRI consult factory
- 90 CRI = R9≥50

Custom Output - Lumens OR Wattage

CL _____ Specify CRI, CCT and desired lumens (i.e. CL835500) *Max lumens approximately 1250 lumens/ft, consult factory for more information*
CW _____ Specify CRI, CCT and desired wattage (i.e. CW9407) *Specify watts between standard offering listed below*

80 CRI

	Color	Output	Lumens <i>per foot</i>	Shielding			
				A Satine Lens		D Diffuse Single	
				LPW	Watts/ft	LPW	Watts/ft
830LO	3000K	Low	500	116	4.3	122	4.1
830MO	3000K	Medium	750	116	6.5	122	6.1
830HO	3000K	High	1000	117	8.6	123	8.1
835LO	3500K	Low	500	119	4.2	125	4.0
835MO	3500K	Medium	750	119	6.3	126	6.0
835HO	3500K	High	1000	120	8.3	126	7.9
840LO	4000K	Low	500	121	4.1	127	3.9
840MO	4000K	Medium	750	121	6.2	128	5.9
840HO	4000K	High	1000	122	8.2	129	7.8

90 CRI

927LO	2700K	Low	500	95	5.3	100	5.0
927MO	2700K	Medium	750	96	7.8	101	7.5
927HO	2700K	High	1000	95	10.5	100	10.0
930LO	3000K	Low	500	98	5.1	103	4.8
930MO	3000K	Medium	750	99	7.6	104	7.2
930HO	3000K	High	1000	98	10.2	103	9.7
935LO	3500K	Low	500	100	5.0	105	4.8
935MO	3500K	Medium	750	101	7.5	106	7.1
935HO	3500K	High	1000	100	10.0	105	9.5
940LO	4000K	Low	500	103	4.9	108	4.6
940MO	4000K	Medium	750	103	7.3	109	6.9
940HO	4000K	High	1000	103	9.7	108	9.3

Length

- All individual units cannot be joined, end plates are factory installed and cannot be removed
- End plates add 4" (2" per end) to the overall length of the fixture/row
- For patterns, refer to Pattern section on next page

2	3	4	5	6	7	8	-
Indiv. Fixture	Indiv. Fixture	Indiv. Fixture	Indiv. Fixture	Indiv. Fixture	Indiv. Fixture	Indiv. Fixture	Cont. Run Specify nominal overall row length to the 1'
24" (609.6mm)							
36" (914.4mm)							
48" (1219.2mm)							
60" (1524mm)							
72" (1828.8mm)							
84" (2133.6mm)							
96" (2438.4mm)							

Specify to the 1'

Specifications and dimensions subject to change without notice. Specification sheets that appear on pinnacle-ltg.com are the most recent version and supersede all other previously printed or electronic versions.

Designed in Denver, CO • USA | pinnacle-ltg.com | O: 303-322-5570 F: 303-322-5568

S3D_LED_SPEC_FEB2024



Patterns

- Specify pattern shape and fixture length
- Length specified will not reflect overall pattern dimensions
- Angles and shapes not shown require MOD Pattern; consult factory
- All connectors are NON ILLUMINATED
- Minimum length for any single part of a pattern is 2'
- All lengths are TO THE FOOT ONLY
- Our in house milling capabilities enable the design and development of any non-standard connector
- Example part number: S3D-A-835HO-Y8x6x8-CAC48JB-U-FSD-1-0-GR
- Connectors add to the overall length of the pattern

S_	R_x	U_x_x	L_x	Y_x_x	X_x_x_x	MOD
Square Provide A dimension Example: S4' 	Rectangle Provide Ax B dimensions Example: R4'x3' 	U-Shape Provide Ax BxC dimensions Example: U3'x4'x3' 	L-Shape Provide Ax B dimensions Example: L3'x3' 	Y-Shape Provide Ax BxC dimensions Example: Y3'x3'x3' 	X-Shape Provide Ax BxCxD dimensions Example: X3'x3'x3'x3' 	Multi Connector Layout For patterns other than shown, factory drawing and sign off required with all MODs
Non-illuminated Connector Details						

Mounting

- Adjustable cable. Specify 48", 120", 240", or 350"
- Specify cable length in ordering code
- End plates attached at factory
- Canopies and mounts match fixture finish see Finish section for additional details
- Approved for dry/damp location unless otherwise noted
- Refer to installation instructions during installation
- Maximum fixture weight is 8 lbs for a standard 4' fixture

CAC__G_ Conductive AC to Grid (specify grid type: G1, G9, GS)
CAC__JB Conductive AC to Junction Box

Mounting Details

- CAC is an integrated power and suspension cable that is smaller in diameter than a traditional SJT cable. CAC is 2 or 4 conductive cables and suspension, standard power cable (SJT) is 5 conductive cables and no suspension.

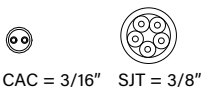

- A larger power side canopy allows for adjustability of the CAC cable inside of the canopy.

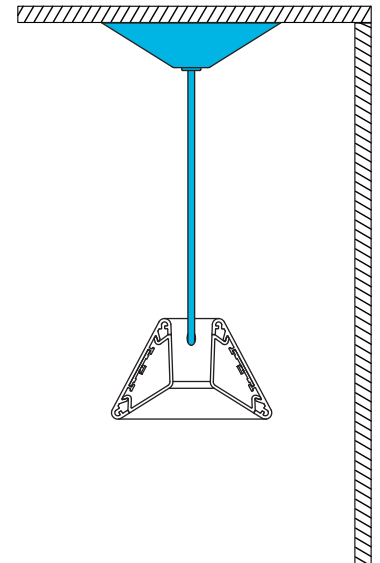
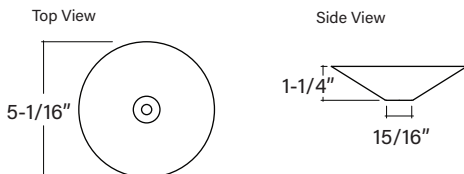



Voltage

- Some SORREL configurations will not accommodate all voltage options; consult with factory

U	Universal
1	120 volt
2	277 volt
3	347 volt

Remote Driver

- Driver count dictated by product configuration
- Standard Driver Option = FSD
- Driver Lifetime: 50,000 hours at 25°C ambient operating conditions
- For more driver options, see Pinnacle Resource Guide
- Some SORREL configurations will not accommodate all driver options; consult with factory
- Configurations with multiple drivers will require Standard Remote Box

0-10V Drivers

FSD	Factory Select Driver, 1%, 0-10v
PL2	Advance Xitanium, 1%, 0-10v
PL4	Advance Xitanium 347v, 1%, 0-10v (requires 347v option)
OL2	eldoLED Optotronic, 1%, 0-10v
OL4	eldoLED Optotronic 347v, 1% 0-10v (requires 347v option)
EE1	eldoLED ECOdrive 1%, 0-10V (logarithmic)
EE2	eldoLED ECOdrive 1%, 0-10V (linear)
ES1	eldoLED SOLOdrive 0%, 0-10V (logarithmic)
ES2	eldoLED SOLOdrive 0%, 0-10V (linear)

DALI Drivers

EE3	eldoLED SOLOdrive .1%, DALI 2, DT6 (logarithmic)
EE4	eldoLED SOLOdrive .1%, DALI 2, DT6 (linear)

Lutron Drivers

LH1	Lutron Hi-lume Soft-on, Fade-to-Black 1%, EcoSystem, LDE1
------------	---

Slim Remote Box

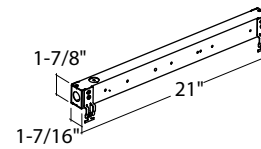

Standard Remote Box

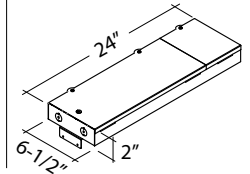

How to specify Circuiting, Battery and Emergency

1

- Select fixture circuiting from options below
- Some SORREL configurations will not accommodate all circuiting options, consult with factory

Circuiting

1	Single Circuit
E	Emergency Circuit entire fixture or row
N	Night Light Circuit entire fixture or row



- Battery and emergency section options are available in addition to fixture circuit
- Select battery and emergency section options below; factory shop drawing required
- Some SORREL configurations will not accommodate all circuiting options, consult with factory
- Configurations with battery or emergency device will require Standard Remote Box

Battery and/or Emergency

0 No battery or specific emergency section required

Remote Battery

- Select battery section type if required, indicate total quantity. *Example 2PLL*
- 90 minute battery runtime; test button is remote to fixture and requires an additional drop
- Battery section will require full length of housing up to 8' on individual fixtures or within continuous row
- For more battery options available, see Pinnacle Resource Guide

_FSB	Factory Select Battery 10w, Lithium
_FSBST	Factory Select Battery 10w, Lithium, Self Testing
_PLL	Bodine 10w, Lithium, Self Testing
_ILL	Iota 10w, Lithium, Self Testing

Standard Remote Box

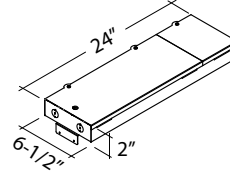

For Approximate Battery Lumen Output

- Multiply battery wattage x fixture LPW shown in Output section
- 10 (watts) x 92.3 (LPW) = 923 battery lumen output

Emergency

- Select emergency section type if required, indicate total quantity. *Example 1E*
- Emergency circuiting sections are for use when specifying emergency options on continuous rows
- Emergency or Night Light section will be entire fixture within continuous row

_FSG	Factory Select ALCR, Emergency Control Device, UNV
_GI	Iota ETS-DR, Emergency Control Device, UNV
_GB	Bodine GTD, Emergency Control Device, 120v or 277v
_E	Emergency Circuit
_N	Night Light Circuit

Battery OR Emergency Ordering Examples

- Single circuit, 10w battery Ordering Code: 1-1PLL
- Emergency only, 10w battery Ordering Code: E-1PLL
- Single circuit, GTD required Ordering Code: 1-1GB

Finish

- Standard powder-coat textured white, metallic silver, textured black, graphite or bronze painted finish; consult factory for chip of standard paint finishes
- Selecting a fixture finish other than white may impact lumen output; consult factory for more information

W	White (<i>white cord/white canopy</i>)
S	Metallic Silver (<i>grey cord/silver canopy</i>)
BL	Textured Black (<i>black cord/black canopy</i>)
BR	Bronze (<i>white cord/bronze canopy</i>)
GR	Graphite (<i>white cord/graphite canopy</i>)
CC	Custom Color (<i>white cord/custom color canopy to match fixture</i>)

Controls

- Pinnacle is able to use solutions from different manufacturers. Consult factory for more information.



Photometrics

Satine Dual Lens

Test # REP-103123-01-V1
 Catalog # S3D-A-840HO
 Lumens 4015
 Watts 32.8
 Efficacy 122.4

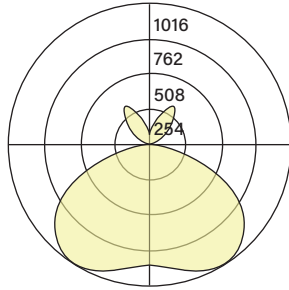

Distribution is 82% direct / 18% indirect

Recommended for mounting distances of 24" or more

Diffuse Single Piece Lens

Test # REP-021423-02
 Catalog # S3D-D-840HO
 Lumens 4069
 Watts 31.8
 Efficacy 128.1

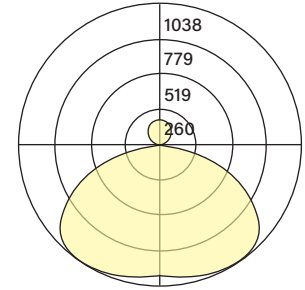

Distribution is 87% direct / 13% indirect

Recommended for mounting distances of 24" or less

Candela Distribution

Vert Angle	Horizontal Angle				
	0	22.5	45	67.5	90
0	878	878	878	878	878
5	872	877	879	883	890
15	841	865	904	934	953
25	783	836	915	973	1005
35	699	786	905	972	1001
45	589	715	840	883	899
55	463	611	702	718	728
65	324	464	525	494	481
75	173	273	258	241	230
85	46	61	39	27	25
90	3	3	3	2	2
95	12	13	9	7	7
105	22	67	41	35	33
115	31	137	101	82	76
125	40	178	186	156	146
135	48	189	266	244	232
145	55	162	286	315	310
155	62	130	216	275	296
165	66	97	145	177	191
175	68	72	78	85	90
180	69	69	69	69	69

Luminance Data (cd/sq.m)

Angle In Degrees	Average 0-Deg	Average 45-Deg	Average 90-Deg
45	8962	12780	13669
55	8672	13168	13641
65	8249	13371	12229
75	7174	10734	9546
85	5636	4836	3033

Candela Distribution

Vert Angle	Horizontal Angle				
	0	22.5	45	67.5	90
0	998	998	998	998	998
5	990	1000	996	1002	998
15	958	981	1001	1024	1028
25	894	938	985	1026	1038
35	804	867	944	999	1019
45	686	771	871	927	945
55	546	652	750	774	779
65	389	499	552	532	522
75	223	302	282	259	249
85	67	66	42	31	27
90	0	0	0	0	0
95	14	8	4	3	3
105	43	36	25	19	18
115	74	68	60	51	49
125	105	100	91	85	83
135	133	129	123	117	115
145	156	154	149	145	144
155	174	173	170	168	166
165	187	187	185	184	183
175	193	195	193	193	193
180	195	195	195	195	195

Luminance Data (cd/sq.m)

Angle In Degrees	Average 0-Deg	Average 45-Deg	Average 90-Deg
45	9179	11658	12637
55	9000	12369	12851
65	8699	12362	11678
75	8148	10290	9110
85	7293	4559	2973

For all available IES files, please visit our website at pinnacle-ltg.com. Photometry testing in accordance to IESNA-LM-79-08 at an IAS accredited testing laboratory. Testing conducted at 25°C ambient conditions

Applications & Certificates

Construction: 6063-T6 Extruded aluminum housing. Highly reflective die-formed white painted reflector.

Shielding: Diffuse snap-in acrylic lens with matte finish, removable for maintenance.

Mounting: Conductive aircraft cable mount available. Power mount supplied with conductive aircraft cable and round 5" diameter canopy. Non-power supplied with aircraft cable and 2" (50.8mm) canopy. Refer to installation instructions for appropriate ceiling detail.

LED: 25°C test environment. Lumen output/wattage has a margin of +/- 5%; 2' or 3' lengths may have a greater wattage deviation. Luminaire configurations tested in accordance with IES LM-79. Diodes tested in accordance with IES LM-80. Lifetime calculated using IES TM-21. Minimum lifetime greater than 60,000 hours. Lifetime Projection L70 = 276,000 hours and L90 = 83,800 hours. MacAdam 3-Step Ellipses. For all available IES files, please visit our website at pinnacle-ltg.com.

CRI, CCT & Output: Not all lumen packages available. Three lumen packages available. Low (LO), Medium (MO), High (HO). Custom outputs are available. Specify custom lumens or watts between standard offering listed on CRI, CCT & Output page. 80 CRI is available for 3000K, 3500K, and 4000K. 90 CRI is available for 2700K, 3000K, 3500K and 4000K. 90 CRI = R9≥50.

Voltage: Universal (U), 120 volt (1), 277 volt (2) and 347 volt (3) options available. Must specify PL4 or OL4 in Driver section when 347 volt (3) is selected. Some SORREL configurations will not accommodate all voltage options; consult with factory.

Driver: Standard Driver Option is Factory Select Driver 0-10V, 1% = FSD. Electronic driver, Power factor is >0.9 with a THD <20%. Driver Lifetime: 50,000 hours at 25°C ambient operating conditions. Ambient operating range: -20°F/-30°C to 98°F/37°C. For more driver options, see Pinnacle Resource Guide. Some SORREL configurations will not accommodate all driver options.

Remote Mounting Guide

Distance limited by max input watts shown.

Max Distance	56'	42'	28'	20'	15'
4' Housing	4.0w/ft	5.3w/ft	7.9w/ft	11.0w/ft	14.3w/ft
8' Housing	N/A	2.6w/ft	3.9w/ft	5.4w/ft	7.3w/ft

Circuiting: Select from Single circuit (1), Emergency circuit (E) or Night Light circuit (N). Housings cannot be split into multiple circuits. Some SORREL configurations will not accommodate all circuiting options; consult with factory.

Battery & Emergency: Select battery or emergency options if required. If battery or emergency option is not required, enter 0. Battery duration is 90 minutes as standard. Test button is remote to fixture. Standard battery and emergency device options will be installed in standard remote box. For more battery options, see Pinnacle Resource Guide.

Finish: Standard powder-coat textured white, metallic silver, textured black, graphite or bronze painted finish; consult factory for chip of standard paint finishes. Contact factory for additional custom color and finish options.

Controls: Consult factory.

Labels: UL and cUL Listed. Low, Medium and High Output lumen packages are approved for dry/damp location unless otherwise noted.

Fixture Weight: Maximum fixture weight is 8 lbs for a standard 4' fixture.

Buy American Act Compliant Some options are not Buy American Act Compliant, please contact factory for more information.

Warranty: SORREL offered with a 5-year limited warranty. Covers LED, driver and fixture.

Specifications and dimensions subject to change without notice. Specification sheets that appear on pinnacle-ltg.com are the most recent version and supersede all other previously printed or electronic versions.

Designed in Denver, CO • USA | pinnacle-ltg.com | O: 303-322-5570 F: 303-322-5568

S3D_LED_SPEC_FEB2024