

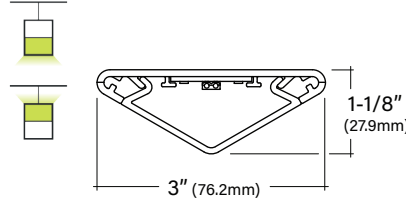

FACTORY DRAWING AND SIGN OFF REQUIRED WITH THIS PRODUCT.



# VERBENA V3AJ

3" Direct and Indirect Linear with Alternating Joint



Indirect Orientation

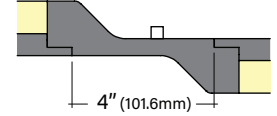

## Specification Features

- Triangular lens form factor with 145LPW direct or 165LPW indirect widespread illumination
- Enhanced lighting pattern with 6% contribution past nadir
- Minimalistic profile with overall height less than 1 1/2" with triangular lens
- Integral suspension and power cable with singular adjustment mechanism
- Triangular lens form factor with up to 2000lm/ft or 2300lm/ft indirect widespread illumination
- Milled X, T, Y, 90°, 120°, 135° connectors, and a direct-to-indirect alternating joint



Example Part #: V3AJ-A-830HO-26'-CAC48JB-U-FSD-1-0-W



<b>V3AJ</b>			
HOUSING	SHIELDING	CRI, CCT & OUTPUT <sup>1</sup>	LENGTH OR PATTERN <sup>2</sup>
<b>V3AJ</b> - Verbena 3 Alternating Joint <i>Housing pg. 2</i>  For straight runs, specify overall nominal length. Use page 7 to draw out the straight run and include all alternating joints while indicating light directionality and shielding.	<b>A</b> - Satine Lens <b>WS</b> - Widespread Lens <i>Shielding pg. 2</i>	_27_ - 2700K _30_ - 3000K _35_ - 3500K _40_ - 4000K CL_____ - Custom Lumens CW_____ - Custom Watts <i>Lumen Output pg. 2</i>	_ - Individual Fixture _ - Continuous Row <b>S</b> - Square <b>H</b> - Hexagon <b>O</b> - Octagon <b>R_x_x</b> - Rectangle <b>L_x_x</b> - L-Shape <b>U_x_x_x</b> - U-Shape <b>Y_x_x_x</b> - Y-Shape <b>T_x_x_x</b> - T-Shape <b>X_x_x_x_x</b> - X-Shape <i>Length and Pattern pg. 2-3</i>
MOUNTING <sup>3</sup>	VOLTAGE	REMOTE DRIVER	CIRCUITING
<b>CAC_x_G</b> - Conductive AC to Grid <b>CAC_x_JB</b> - Conductive AC to J Box <i>Mounting pg. 3</i>	<b>U</b> - Universal (120 thru 277V) <b>1</b> - 120V <b>2</b> - 277V <b>3</b> - 347V <i>Voltage pg. 4</i>	<b>FSD</b> - Factory Select Driver (1%, 0-10v) <b>PL2</b> - Advance Xitanium (1%, 0-10v) <b>OL2</b> - eldoLED Optotronic (1%, 0-10v) <b>OL4</b> - eldoLED Optotronic 347V (1%, 0-10v) <b>EE1</b> - eldoLED ECOdrive (1%, 0-10v) <b>ES1</b> - eldoLED SOLOdrive (0.1%, 0-10v) <b>LH1</b> - Lutron Hi-lume (1%, EcoSystem) <i>Driver pg. 4</i>	<b>1</b> - Single Circuit <b>2</b> - Dual Circuit <b>E</b> - Emergency ( <i>entire fixture</i> ) <b>N</b> - Night Light ( <i>entire fixture</i> ) <i>Circuiting pg. 4</i>
BATTERY & EMERGENCY <sup>4</sup>	FINISH	CONTROLS	
<b>0</b> - None _FSB - Factory Select Battery _FSG - Factory Select ALCR _GI - Iota ETS DR _GB - Bodine GTD _ILL - Iota 10W _PLL - Bodine 10W _E - Emergency Section _N - Night Light Section <i>Battery and Emergency pg. 5</i>	<b>W</b> - White <b>S</b> - Metallic Silver <b>BL</b> - Textured Black <b>BR</b> - Bronze <b>GR</b> - Graphite <b>CC</b> - Custom Color <i>Finish pg. 5</i>	Pinnacle is able to accommodate different control solutions from different manufacturers. Consult Factory for more information.	

<sup>1</sup>When specifying CRI, CCT & OUTPUT the first \_ is for specifying either 8 - 80CRI or 9 - 90CRI. The ending \_\_ are for specifying output, example HO - High Output. See output charts for more information. <sup>2</sup>Continuous row comes in 1' increments starting at 2'. For straight runs specify overall nominal length and use last page to draw out how the length should be broken down into directions. For patterns specified length will be fixture length. Patterns will be longer than specified length. For Mod layouts consult factory. <sup>3</sup>Specify CAC length standard CAC is 48". Specify grid: G1=15/16", G9=9/16", GS=Screw Slot. Example: CAC48G1 <sup>4</sup>Enter quantity for Battery and Emergency, Example 1PLL.

Specifications and dimensions subject to change without notice. Specification sheets that appear on pinnacle-ltg.com are the most recent version and supersede all other previously printed or electronic versions.



Shielding

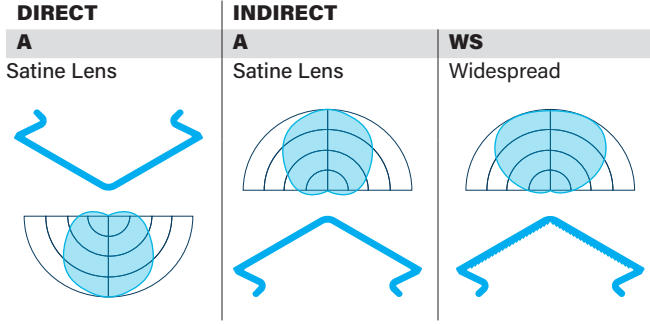

Output

- Specify either 80 or 90 CRI
- Longer lead-time may apply for 90 CRI. Consult factory.
- 90 CRI = R9≥50

Custom Output - Lumens OR Wattage

CL _____	Specify CRI, CCT and desired lumens (i.e. CL835500)	Total Max lumens: A Lens- 2,044, WS Lens- 2,312. Max lumens dependant on color temp. Consult factory for more information
CW _____	Specify CRI, CCT and desired wattage (i.e. CW9407)	Total Max watts: 14.8. Consult factory for more information

80 CRI

	Color	Output	Lumens per foot	Shielding			
				A Satine Lens		WS Widespread	
				LPW	Watts/ft	LPW	Watts/ft
830LO	3000K	Low	500	142	3.5	161	3.1
830MO	3000K	Medium	750	141	5.3	160	4.7
830HO	3000K	High	1000	141	7.1	158	6.3
835LO	3500K	Low	500	146	3.4	164	3.0
835MO	3500K	Medium	750	145	5.2	164	4.6
835HO	3500K	High	1000	145	6.9	163	6.1
840LO	4000K	Low	500	148	3.4	167	3.0
840MO	4000K	Medium	750	147	5.1	167	4.5
840HO	4000K	High	1000	146	6.9	166	6.0

90 CRI

927LO	2700K	Low	500	115	4.3	131	3.8
927MO	2700K	Medium	750	114	6.6	130	5.8
927HO	2700K	High	1000	113	8.8	129	7.8
930LO	3000K	Low	500	119	4.2	136	3.7
930MO	3000K	Medium	750	118	6.4	134	5.6
930HO	3000K	High	1000	117	8.5	134	7.5
935LO	3500K	Low	500	121	4.1	138	3.6
935MO	3500K	Medium	750	120	6.3	136	5.5
935HO	3500K	High	1000	119	8.4	136	7.3
940LO	4000K	Low	500	125	4.0	142	3.5
940MO	4000K	Medium	750	123	6.1	140	5.3
940HO	4000K	High	1000	122	8.2	140	7.1

Length

- All individual units cannot be joined, end plates are factory installed and cannot be removed
- End caps add 2-1/2" (1-1/4" per end) to the overall length of the fixture/row, end caps do not add to mounting distance
- For patterns, refer to Pattern section on next page

1	2	3	4	5	6	7	8	-
Indiv. Fixture	Indiv. Fixture	Indiv. Fixture	Indiv. Fixture	Indiv. Fixture	Indiv. Fixture	Indiv. Fixture	Indiv. Fixture	Cont. Run Specify nominal overall row length to the 1'
12" (304.8mm)								
	24" (609.6mm)							
		36" (914.4mm)						
			48" (1219.2mm)					
				60" (1524mm)				
					72" (1828.8mm)			
						84" (2133.6mm)		
							96" (2438.4mm)	

Specify to the 1' >>>>

Specifications and dimensions subject to change without notice. Specification sheets that appear on pinnacle-ltg.com are the most recent version and supersede all other previously printed or electronic versions.

Designed in Denver, CO • USA | pinnacle-ltg.com | O: 303-322-5570 F: 303-322-5568

V3AJ\_LED\_SPEC\_NOV2023



## Patterns

- If using alternating joint with patterns use last page to draw out the pattern
- Direction of light must be the same on all sides of a connector, can only change direction of light in straight section
- Specify pattern shape and requested fixture length
- Length specified will not reflect overall pattern dimensions
- Angles and shapes not shown require Mod Pattern; consult factory
- All connectors are NON ILLUMINATED
- Driver/Battery Count dictated by product configuration
- Minimum length for any single part of a pattern is 2'
- All lengths are TO THE FOOT ONLY

S_	H_	O_	R_x	U_x_x	L_x	Y_x_x	T_x_x	X_x_x_x	MOD
Square Provide A dimension Example: <b>S12'</b>	Hexagon Provide A dimension Example: <b>H12'</b>	Octagon Provide A dimension Example: <b>O12'</b>	Rectangle Provide Ax B dimensions Example: <b>R16'x12'</b>	U-Shape Provide Ax BxC dimensions Example: <b>U12'x16'x12'</b>	L-Shape Provide Ax B dimensions Example: <b>L12'x12'</b>	Y-Shape Provide Ax BxC dimensions Example: <b>Y12'x16'x12'</b>	T-Shape Provide Ax BxC dimensions Example: <b>T12'x12'x12'</b>	X-Shape Provide Ax BxCxD dimensions Example: <b>X12'x16'x12'x16'</b>	Multi Connector Layout For patterns other than shown, factory drawing and sign off required with all MODS

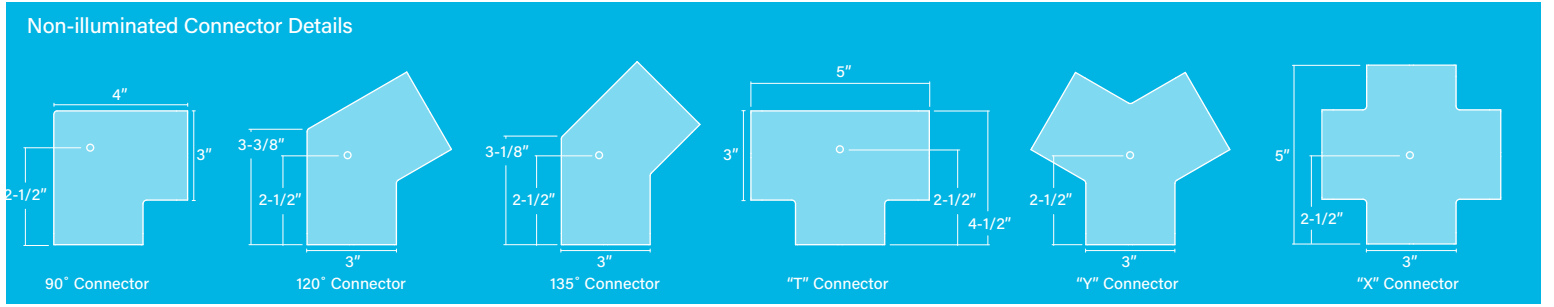

## Mounting

- Driver/Battery Count dictated by product configuration
- Specify cable length in ordering code (CAC48JB)
- Standard adjustable cable. Specify 48", 120", 240", or 350"
- End plates attached at factory
- Canopies and mounts match fixture finish. See Finish section for additional details.
- Approved for dry/damp location unless otherwise noted
- Refer to installation instructions during installation at the job site
- Maximum fixture weight is 10 lbs for a standard 4' fixture

**CAC\_\_G\_** Conductive AC to Grid (specify grid type: G1, G9, GS)  
**CAC\_\_JB** Conductive AC to Junction Box

### CAC Canopy Details

- CAC is an integrated power and suspension cable that is smaller in diameter than a traditional SJT cable. CAC is 2 conductive cables and suspension, standard power cable (SJT) is 5 conductive cables and no suspension.

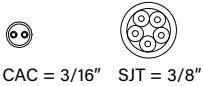

- A larger power side canopy allows for adjustability of the CAC cable inside of the canopy.

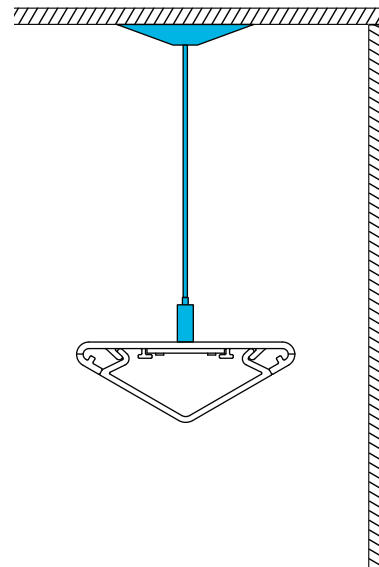
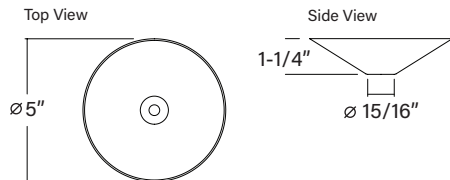

Specifications and dimensions subject to change without notice. Specification sheets that appear on pinnacle-ltg.com are the most recent version and supersede all other previously printed or electronic versions.



## Voltage

- Some VERBENA configurations will not accommodate all voltage options; consult with factory

<b>U</b>	Universal
<b>1</b>	120 volt
<b>2</b>	277 volt
<b>3</b>	347 volt

## Remote Driver

- Driver/Battery Count dictated by product configuration
- Standard Driver Option = FSD
- Driver Lifetime: 50,000 hours at 25°C ambient operating conditions
- For more driver options, see Pinnacle Resource Guide
- Some VERBENA configurations will not accommodate all driver options; consult with factory
- All configurations with no PLL, ILL or Emergency Control Device options will use Slim Remote Box

Slim Remote Box

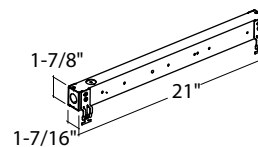

### 0-10V Drivers

<b>FSD</b>	Factory Select Driver (1%, 0-10v)
<b>PL2</b>	Signify Advance Xitanium 1%, 0-10v
<b>OL2</b>	eldoLED Optotronic, 1%, 0-10v
<b>OL4</b>	eldoLED Optotronic 347v, 1% 0-10v, requires 347v option
<b>EE1</b>	eldoLED ECOdrive 1%, 0-10v Logarithmic
<b>EE2</b>	eldoLED ECOdrive 1%, 0-10v Linear
<b>ES1</b>	eldoLED SOLOdrive 0-10v, 0.1% Logarithmic
<b>ES2</b>	eldoLED SOLOdrive 0-10v, 0% Linear

### DALI Drivers

<b>EE3</b>	eldoLED ECOdrive .1%, DALI (logarithmic)
<b>ES3</b>	eldoLED SOLOdrive .1%, DALI (logarithmic)

### Lutron Drivers

<b>LH1</b>	Lutron Hi-lume Soft-on, Fade-to-black 1%, EcoSystem, LDE1
<b>LH4</b>	Lutron Hi-Lume 1%, 2-wire, Lutron-LTEA2W, 120v only

## How to specify Circuiting, Battery and Emergency

- Select fixture circuiting from options below
  - Some VERBENA configurations will not accommodate all circuiting options, consult with factory

## Circuiting

<b>1</b>	Single Circuit
<b>2</b>	Dual Circuit
<b>E</b>	Emergency Circuit only
<b>N</b>	Night Light Circuit only

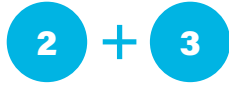

- Battery and emergency section options are available in addition to fixture circuit
- Select battery and emergency section options below; factory shop drawing required
- Some VERBENA configurations will not accommodate all circuiting options, consult with factory
- Configurations with PLL or ILL or any Emergency control device will require standard remote box.

**Battery and/or Emergency** *If Required*

**0** No battery or specific emergency section required

**Battery**

- Select battery section type if required, indicate total QTY. *Example 2PLL*
- 90 minute battery runtime; test button is remote to fixture and requires an additional drop
- Entire direct fixture housing is on battery for individual fixtures
- For more battery options available, see Pinnacle Resource Guide

<b>0</b>	No Battery
<b>_FSB</b>	Factory Select Battery (10w option)
<b>_FSBST</b>	Factory Select Battery (10w, Self Testing)
<b>_ILL</b>	lota 10w Lithium, Self Testing
<b>_IRC</b>	lota 10w Remote
<b>_IRH</b>	lota 20w Remote
<b>_PRL</b>	Bodine 7w Remote
<b>_PRS</b>	Bodine 7w Remote, Self Testing
<b>_PRH</b>	Bodine 20w Remote
<b>_PLL</b>	Bodine 10w Lithium, Self Testing
<b>_PRD</b>	Bodine 10w Remote, Dual Flex

Standard Remote Box

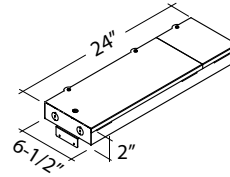

**For Approximate Battery Lumen Output**

- Multiply battery wattage X fixture LPW shown on Lumen Table
- 92.3 (LPW) x 10 (watts) = 923 battery lumen output

**Emergency**

- Select emergency section type if required, indicate total QTY. *Example 1E*
- Combine battery and emergency section ordering codes if both options are selected
- Emergency circuiting sections are for use when specifying emergency options on continuous runs

<b>_FSG</b>	Factory Select Automatic Load Control Relay (ALCR), UNV
<b>_GI</b>	Emergency Transfer Switch (ETS) DR Emergency Control Device, UNV
<b>_GB</b>	Bodine GTD, Generator Transfer Device, 120v or 277v
<b>_E</b>	Emergency circuit
<b>_N</b>	Night Light circuit
<b>_L</b>	Life Safety circuit section NO THROUGH WIRE

**Battery OR Emergency Ordering Examples**

- Single circuit, 10w Integral Battery      Ordering Code: 1-1PLL
- Emergency only, 10w Integral Battery      Ordering Code: E-1PLL
- Single circuit, GTD required      Ordering Code: 1-1GB

**Combination Section Ordering Examples**

- Single circuit, (1) 10w battery, (1) emergency section      Ordering Code: 1-1PL1E
- Multi circuit, (2) 10w battery, (2) emergency sections      Ordering Code: M-2PLL2E
- Single circuit, (1) night light section      Ordering Code: 1-1N

**Finish**

- Standard powder-coat textured white, metallic silver, textured black, graphite or bronze painted finish; consult factory for chip of standard paint finishes
- Selecting a fixture finish other than white may impact lumen output; consult factory for more information

<b>W</b>	White ( <i>white cord/white canopy</i> )
<b>S</b>	Metallic Silver ( <i>grey cord/silver canopy</i> )
<b>BL</b>	Textured Black ( <i>black cord/black canopy</i> )
<b>BR</b>	Bronze ( <i>white cord/bronze canopy</i> )
<b>GR</b>	Graphite ( <i>white cord/graphite canopy</i> )
<b>CC</b>	Custom Color ( <i>white cord/CC canopy to match fixture</i> )

**Controls**

- Pinnacle is able to accommodate different control solutions from different manufacturers. Consult Factory for more information.

*Specifications and dimensions subject to change without notice. Specification sheets that appear on pinnacle-ltg.com are the most recent version and supersede all other previously printed or electronic versions.*



## Photometrics

### Satine Lens

Test # KPL2015-2  
 Catalog # V3D-A-N-40-4  
 Lumens 3868 Lm  
 Watts 27.5 W  
 Efficacy 141 LPW

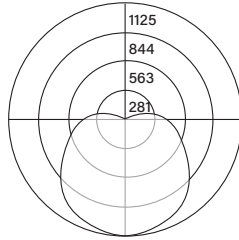

### Widespread Lens

Test # KPL2015-1  
 Catalog # V3I-N-WS-40-4  
 Lumens 3883 Lm  
 Watts 24.2 W  
 Efficacy 161 LPW

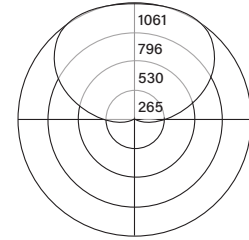

### Candela Distribution

Vert Angle	Horizontal Angle				
	0	22.5	45	67.5	90
0	1117	1117	1117	1117	1117
5	1110	1114	1109	1109	1113
10	1110	1114	1109	1109	1113
15	1095	1099	1095	1096	1100
20	1095	1099	1095	1096	1100
25	1071	1074	1072	1073	1077
30	1071	1074	1072	1073	1077
35	1036	1041	1039	1042	1047
40	1036	1041	1039	1042	1047
45	994	999	998	1002	1007
50	994	999	998	1002	1007
55	942	947	949	953	960
60	942	947	949	953	960
65	884	889	892	897	905
70	884	889	892	897	905
75	818	822	828	837	843
80	818	822	828	837	843
85	747	750	757	770	778
90	747	750	757	770	778

### Luminance Data (cd/sq.m)

Angle In Degrees	Average 0-Deg	Average 45-Deg	Average 90-Deg
45	14199	11327	10779
55	13556	10171	9731
65	12502	8940	9357
75	10627	8679	9572
85	8488	8857	9984

### Candela Distribution

Vert Angle	Horizontal Angle				
	0	22.5	45	67.5	90
90	13	92	201	255	259
95	48	130	260	320	324
100	98	181	323	391	394
105	162	234	388	466	472
110	237	304	456	546	556
115	315	382	526	624	631
120	397	459	607	701	709
125	474	539	687	781	789
130	556	618	762	856	865
135	637	693	826	919	929
140	711	764	882	968	977
145	784	829	926	1002	1011
150	850	886	964	1024	1032
155	909	935	993	1037	1043
160	960	977	1015	1043	1048
165	999	1010	1031	1046	1050
170	1029	1032	1043	1048	1051
175	1046	1048	1050	1049	1051
180	1052	1052	1052	1052	1052

For all available IES files, please visit our website at [pinnacle-ltg.com](http://pinnacle-ltg.com). Photometry testing in accordance to IESNA-LM-79-08 at an NVLAP accredited testing laboratory. Testing conducted at 25°C ambient conditions



## Multi Connector Layout

- Use the below to sketch your desired pattern. Available fixture and connectors are listed in the legend. Label your pattern components according to legend to simplify specification.
- Label the linear sections with length, and light direction - Direct (**D**) or Indirect (**I**), and shielding - Satine (**A**) or Widespread (**WS**); example 4D-A would be 4' Direct with Satine Lens.
- Cannot use connector with another connector.
- Fixtures available in 1', 2', 3', 4', 5', 6', 7', and 8' lengths. All lengths are TO THE FOOT ONLY.
- CAN BE DONE: Alternating inbetween connectors ie. connector-8D-4I-8D-connector
- CANNOT BE DONE: Alternating at connectors ie. connector-8D-connector-8I

**Joint**

4"

**Connectors**

**C90**  
90° Connector

**C120**  
120° Connector

**C135**  
135° Connector

**T**  
"T" Connector

**Y**  
"Y" Connector

**X**  
"X" Connector

**AJ**  
Alternating Joint

**Example Part Number using Alternating Joint:**  
V3AJ-A-830-12'-AC48JB-U-FSD-2-0-W

**How to draw it out:**

Specifications and dimensions subject to change without notice. Specification sheets that appear on pinnacle-ltg.com are the most recent version and supersede all other previously printed or electronic versions.



## Applications & Certificates

**Construction:** 6063-T6 Extruded aluminum housing. Highly reflective die-formed white painted reflector.

**Shielding:** Diffuse snap-in acrylic lens with matte finish, removable for maintenance.

**Mounting:** Conductive Aircraft cable, wall and surface mount available. Power mount supplied with conductive aircraft cable and oval 6-1/2" H x 4-1/4" W canopy. Non-power supplied with aircraft cable and 2" (50.8mm) canopy. Refer to installation instructions for appropriate ceiling detail. Canopies are painted white unless otherwise specified. Maximum fixture weight is 10 lbs for a standard 4' fixture.

**LED:** 25°C test environment. Lumen output/wattage has a margin of +/- 5%; 2' or 3' lengths may have a greater wattage deviation. Luminaire configurations tested in accordance with IES LM-79. Diodes tested in accordance with IES LM-80. Lifetime calculated using IES TM-21. Minimum lifetime greater than 60,000 hours. L70 = 124,900 hours and L90 = 37,200 hours. MacAdam 3-Step Ellipses. Not all products are Lighting Facts listed. For all available IES files, please visit our website at [pinnacle-ltg.com](http://pinnacle-ltg.com).

**CRI, CCT & Output:** Three lumen packages available. Low (LO), Medium (MO) and High (HO). Custom outputs are available. Specify custom lumens or watts between standard offering listed on CRI, CCT & Output page. 80 CRI is available for 3000K, 3500K, and 4000K. 90 CRI is available for 2700K, 3000K, 3500K, and 4000K. 90 CRI = R9≥50.

**Voltage:** Universal (U), 120 volt (1), 277 volt (2) and 347 volt (3) options available. Must specify OL4 in Driver section when 347 volt (3) is selected. Some VERBENA configurations will not accommodate all voltage options; consult with factory.

**Driver:** Standard Driver option is Factory Selected Driver 0-10V, 1% = FSD. Electronic driver, Power factor is >0.9 with a THD <20%. Driver Lifetime: 50,000 hours at 25°C ambient operating conditions. Ambient operating range: -20°F/-30°C to 107°F/42°C. For more driver options, see Pinnacle Resource Guide. Some VERBENA configurations will not accommodate all driver options.

**Circuiting:** Select from single circuit (1), Emergency circuit (E) or Night Light circuit (N).

### Remote Mounting Guide

Distance limited by max input watts shown.

Max Distance	56' (.53A)	42' (.7A)	28' (1.05A)	20' (1.5A)	12' (2A)
4' Housing	4.0w/ft	5.4w/ft	8.2w/ft	11.9w/ft	16.1w/ft
8' Housing	N/A	2.6w/ft	4.0w/ft	5.8w/ft	7.8w/ft

For emergency circuiting situations that require no through wire or circuit separation, Life Safety Circuit should be selected. This will provide a separate power feed and only the Life Safety Circuit in that section. Some VERBENA configurations will not accommodate all circuiting options; consult with factory.

**Battery & Emergency:** Select battery or emergency options if required. If battery or emergency option is not required, enter 0. Battery duration is 90 minutes as standard. Test button is remote to fixture. For more Battery options, see Pinnacle Resource Guide.

**Finish:** Standard powder-coat textured white, metallic silver, textured black, graphite or bronze painted finish; consult factory for chip of standard paint finishes. Canopies painted white unless specified differently in the options section of the part number. Contact factory for additional custom color and finish options.

**Controls:** Consult factory.

**Labels:** UL and cUL 2108 Listed. Low, Medium and HO lumen packages are approved for dry/damp location unless otherwise noted.

**Fixture Weight:** Maximum fixture weight is 10 lbs for a standard 4' fixture.

**Buy American Act Compliant**

**Warranty:** VERBENA offered with a 5-year limited warranty. Covers LED, driver and fixture.